

Installation Guide

Agilent Technologies

PSG Family Signal Generators

This guide applies to the signal generator models and associated serial number prefixes listed below. Depending on your firmware revision, signal generator operation may vary from descriptions in this guide.

E8241A: US4124
E8244A: US4124

E8251A: US4124
E8254A: US4124



Part Number: E8251-90022

Printed in USA

February 2002

© Copyright 2001, 2002 Agilent Technologies Inc.

1. Safety Information	1
Warnings, Cautions, and Notes	2
Instrument Markings	3
General Safety Considerations	4
2. Getting Started	5
Checking the Shipment	6
Meeting Electrical and Environmental Requirements	7
Environment	7
Ventilation	7
Line Settings	8
Connecting the AC Power Cord	8
AC Power Cord Localization	9
Configuring Global Settings	10
Adjusting the Display	10
Configuring for Remote Control	12
GPIB Interface Configuration	12
LAN Interface Configuration	12
RS-232 Interface Configuration	13
Ordering Accessories	14
Front Handles and Rack Mount Flanges	14
PSG Documentation	15
Proper Usage and Cleaning	16
Cleaning Suggestions	16
Contacting Agilent Technologies	17
Returning a Signal Generator to Agilent Technologies	18
3. Operation Verification	19
Performing Operation Verification	20
Performing a Self-Test	21
Self-Test Failure	22
Checking the Maximum Leveled Power	23
Maximum Leveled Power Check Failure	24
Checking the Output Power	25
Problems with Output Power	28
4. Regulatory Information	29
Statement of Compliance	30

Contents

Warranty.....	31
Limitation of Warranty.....	31
Exclusive Remedies	31
Assistance.....	32
Certification	33
Declaration of Conformity.....	34
Compliance with German Noise Requirements.....	35

1 Safety Information

Warnings, Cautions, and Notes

The following safety notations are used throughout this manual. Familiarize yourself with each notation and its meaning before operating the signal generator.

WARNING *Warning* denotes a hazard. It calls attention to a condition or situation that could result in personal injury or loss of life. Do not proceed beyond a warning until the indicated conditions or situations are fully understood.

CAUTION *Caution* calls attention to a possible condition or situation that could result in the loss of a user's work, damage, or destruction of the signal generator. Do not proceed beyond a caution until the indicated conditions are fully understood.

NOTE *Note* calls the user's attention to an important point, or special information, within the text. It provides operational information or additional instructions of which the user should be aware.

Instrument Markings

The following markings are used on the signal generator. Familiarize yourself with each marking and its meaning before operating the signal generator.



The instruction manual symbol. The product is marked with this symbol when it is necessary for the user to refer to the instructions in the manual.



The CE mark is a registered trademark of the European Community. If this symbol is accompanied by a year, it is the year when the design was proven.



The CSA mark is a registered trademark of the Canadian Standards Association.



The C-Tick Mark is a trademark registered to the Australian Spectrum Management Agency. This indicates compliance with all Australian EMC regulatory information.



This symbol is used to mark the on position of the power line switch.



This symbol is used to mark the standby position of the power line switch.



This symbol indicates that the input power required is ac.

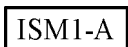

This is a symbol of an Industrial Scientific and Medical Group 1 Class A product. (CISPER 11, Clause 4)

General Safety Considerations

WARNING **Personal injury may result if the signal generator covers are removed. There are no operator serviceable parts inside. To avoid electrical shock, refer servicing to qualified personnel.**

2 Getting Started

Checking the Shipment

1. Inspect the shipping container for damage.

Signs of damage may include a dented or torn shipping container or cushioning material that shows signs of unusual stress or compacting.

2. Carefully remove the contents from the shipping container and verify that your order is complete.

The following items are shipped standard with each signal generator:

- installation guide
- documentation CD-ROM

CD-ROM contents are also available in hard copy format. Refer to [“PSG Documentation” on page 15](#) for more information.

- service software
 - three-prong ac power cord specific to geographic location
3. Verify that any options ordered are included with the shipment by checking the serial number label on the rear of the signal generator and the packing literature included with the shipment.

NOTE The serial number label on the signal generator only verifies hardware/firmware options. The packing literature verifies all items shipped.

Front handles and rack mounting hardware are also available for your signal generator. Refer to [“Front Handles and Rack Mount Flanges” on page 14](#) for more information.

Meeting Electrical and Environmental Requirements

Environment

The signal generator is designed for use in the following environmental conditions:

- indoor use
- < 15,000 feet (4,572 meters) altitude
- 0 to 55° C temperature, unless otherwise specified
- 80% relative humidity (maximum) for temperatures up to 31° C, decreasing linearly to 50% relative humidity at 40° C

CAUTION This product is designed for use in INSTALLATION CATEGORY II and POLLUTION DEGREE 2, per IEC 61010 and 664, respectively.

Ventilation

Ventilation holes are located on the left side of the signal generator cover and the rear of the signal generator chassis. Do not allow these holes to be obstructed, as they allow air flow through the signal generator.

When installing the signal generator in a cabinet, the convection into and out of the signal generator must not be restricted. The ambient temperature outside the cabinet must be less than the maximum operating temperature of the signal generator by 4° C for every 100 watts dissipated within the cabinet.

CAUTION Damage to the signal generator may result when the total power dissipated in the cabinet is greater than 800 watts. When this condition exists, forced convection must be applied.

Line Settings

The signal generator has an autoranging line voltage input. The available ac power source must meet the following conditions:

Voltage:	100/115 volts nominal (90-132 volts) 230/240 volts nominal (198-254 volts)
Frequency:	for 100/115 volts: 50/60/400 Hz nominal for 230/240 volts: 50/60 Hz nominal
Power:	200 watts maximum

CAUTION Damage to the signal generator may result if the supply voltage is not within the specified range.

Connecting the AC Power Cord

This is a Safety Class 1 Product provided with a protective earth ground incorporated into the power cord. The front panel switch is only a standby switch; it is not a line switch. The ac power cord is the disconnecting device that disconnects the signal generator mains circuits from the mains supply. Alternatively, an external switch or circuit breaker, readily identifiable and easily reached by the operator, may also be used as a disconnecting device.

Perform the following steps when connecting the ac power cord:

WARNING **Personal injury may occur if there is any interruption of the protective conductor inside or outside of the signal generator. Intentional interruption is prohibited.**









CAUTION Damage to the signal generator may result without adequate earth grounding. Always use the three-prong ac power cord supplied with the signal generator. See, [“AC Power Cord Localization” on page 9](#) for a list of available power cords.

1. Ensure that the power cord is not damaged.
2. Install the signal generator so that one of the following items is readily identifiable and easily reached by the operator: ac power cord, alternative switch, or circuit breaker.
3. Insert the mains plug into a socket outlet provided with a protective earth grounding.

AC Power Cord Localization

The ac power cord included with the signal generator is appropriate to its geographic location. However, you can order additional ac power cords for use in different areas.

The following table lists the available ac power cords, illustrates plug configurations, and identifies the geographic area in which each cord is appropriate.

Plug Type ^a	Cable Part Number	Plug ^b Description	Length cm (in.)	Cable Color	For Use in Country
250V 	8120-1351	Straight BS 1363A	229 (90)	Mint Gray	Option 900 United Kingdom, Hong Kong, Cyprus, Nigeria, Singapore, Zimbabwe
	8120-1703	90°	229 (90)	Mint Gray	
250V 	8120-1369	Straight AS 3112	210 (79)	Gray	Option 901 Argentina, Australia, New Zealand, Mainland China
	8120-0696	90°	200 (78)	Gray	
125V 	8120-1378	Straight NEMA 5-15P	203 (80)	Jade Gray	Option 903 United States, Canada, Brazil, Colombia, Mexico, Philippines, Saudi Arabia, Taiwan
	8120-1521	90°	203 (80)	Jade Gray	
125V 	8120-4753	Straight NEMA 5-15P	229 (90)	Gray	Option 918 Japan
	8120-4754	90°	229 (90)	Gray	
250V 	8120-1689	Straight CEE 7/VII	200 (78)	Mint Gray	Option 902 Continental Europe, Central African Republic, United Arab Republic
	8120-1692	90°	200 (78)	Mint Gray	
230V 	8120-2104	Straight SEV Type 12	200 (78)	Gray	Option 906 Switzerland
	8120-2296	90°	200 (78)	Gray	
220V 	8120-2956	Straight SR 107-2-D	200 (78)	Gray	Option 912 Denmark
	8120-2957	90°	200 (78)	Gray	
250V 	8120-4211	Straight IEC 83-B1	200 (78)	Mint Gray	Option 917 South Africa, India
	8120-4600	90°	200 (78)	Mint Gray	
250V 	8120-5182	Straight SI 32	200 (78)	Jade Gray	Option 919 Israel
	8120-5181	90°	200 (78)	Jade Gray	

a. E = earth ground, L = line, and N = neutral.

b. Plug identifier numbers describe the plug only. The part number is for the complete cable assembly.

plugs

Configuring Global Settings

Adjusting the Display

You can adjust LCD display on the signal generator. Adjustments can be made to contrast, brightness, screen saver mode, and the screen saver delay. Features such as inverse video, display updating in remote mode, and the screen saver can be turned on or off.

Contrast and Brightness

Press  to decrease the display contrast.

Pressing the decrease contrast hardkey and holding it down causes the display background to gradually darken in comparison to the text on the display. The minimum contrast setting is not a completely black display. Some contrast between the background and the text will still be visible.

Press  to increase the display contrast.

Pressing the increase contrast hardkey and holding it down causes the display background to gradually brighten in comparison to the text on the display. If the background does not appear to change, it is probably set to the maximum contrast.

Press **Utility > Display > Brightness**.

This allows you to change the display's brightness.

Brightness can be adjusted using the arrow keys, numeric keypad, or front panel knob. The brightness value is set to 50 (maximum brightness) at the factory. The minimum brightness value is 1.

Inverse Video

Press **Utility > Display > Inverse Video Off On**.

This toggles between inverse video mode and normal display mode.

The normal display mode for the signal generator is dark text on a light background. Inverse video mode is light text on a dark background. Inverse video is a persistent state; it is not affected by a signal generator preset or power cycle.

Screen Saver

Press **Utility > Display > Screen Saver Off On**.

This toggles the operating mode of the screen saver.

You can increase the life expectancy of the signal generator's display light by activating the screen saver. Leaving the display lit for long periods of time or turning the display on and off frequently decreases the life of the bulb. With the screen saver on, the display light is turned off after a defined period of time with no input to the front panel. The display light turns on again when any front panel key is pressed or when a remote command is sent. The screen saver is set to off at the factory.

Press **Utility > Display > Screen Saver Mode**.

This toggles the screen saver mode between light-only mode and light-and-text mode.

You can adjust the screen saver mode to turn the light on and off or to turn both the light and text on and off. Setting the mode to light-only mode turns the display light off, but the text remains visible at a low intensity. To prevent the text from burning the display, if you are leaving the display unchanged for long periods of time, set the mode to light and text. This mode turns the display light and the text off.

Press **Utility > Display > Screen Saver Delay**.

This adjusts the amount of elapsed time before the screen saver is activated.

The screen saver delay is set to 1 hour at the factory. The current screen saver delay is displayed in the softkey label and also in the active entry area. To change the delay, enter a new value using the numeric keypad and then press **Enter**, or rotate the front panel knob. The acceptable range of delay values is 1 through 12 hours in 1 hour increments.

The screen saver settings are persistent states; they are not affected by a signal generator preset or power cycle.

Updating the Display During Remote Operation

Press **Utility > Display > Update in Remote Off On**.

This toggles the display-update-in-remote mode on or off.

When toggled on, commands executed via the remote control bus will update the signal generator display accordingly. When toggled off, commands executed via the remote control bus will not update the signal generator's display. Update-in-remote mode is set to off at the factory.

Configuring for Remote Control

GPIB Interface Configuration

1. Press **Utility > GPIB/RS-232 LAN > GPIB Address**.

2. Use the numeric keypad to set the desired address.

Alternatively, the arrow keys or the front panel knob can be used to set the desired address. If either alternative is used, step 3 is not required.

3. Press **Enter**.

The signal generator's GPIB address is set to 19 at the factory. The acceptable range of addresses is 0 through 30. The GPIB address is a persistent state; it is not affected by a signal generator preset or by a power cycle.

LAN Interface Configuration

1. Press **Utility > GPIB/RS-232 LAN > LAN Setup**.

2. Press **Hostname**.

3. Use the labeled text softkeys and/or numeric keypad to enter the desired hostname. To erase the current hostname, press **Editing Keys > Clear Text**.

4. Press **Enter**.

5. Press **IP Address** and enter a desired address.

Use the left and right arrow keys to move the cursor. Use the up and down arrow keys, front panel knob, or numeric keypad to enter an IP address. To erase the current IP address, press the **Clear Text** softkey.

6. Press **Enter > Proceed With Reconfiguration > Confirm Change (Instrument will Reboot)**. The signal generator will reboot with the revised settings saved.

This assigns a hostname and IP address to the signal generator. The host name and IP address are persistent states; they are not affected by an instrument preset or a power cycle.

RS-232 Interface Configuration

1. Press **Utility > GPIB/RS-232 LAN > RS-232 Setup**.
2. Press **RS-232 Baud Rate**.
3. Press the desired baud rate softkey.
4. Press **RS-232 Echo Off On**.

This toggles the state of the SCPI echoing on the RS-232 connection. Set as desired.

5. Press **Trans/Recv Pace None Xon**.

This toggles from no handshaking (**Trans/Recv Pace None**) to XON/XOFF handshaking (**Trans/Recv Pace Xon**) when transmitting or receiving data via RS-232. Set as desired.

6. Press **Reset RS-232**.

This deletes the data from the RS-232 buffer. Pressing this key will discard any unprocessed SCPI input received over RS-232.

These RS-232 parameters are persistent states; these states are not affected by an instrument preset or power cycle.

Ordering Accessories

The following accessories can be ordered when a signal generator is purchased, or at any time afterward. To order accessories, refer to [“Contacting Agilent Technologies” on page 17](#).

Front Handles and Rack Mount Flanges

Handles can be attached to the front of the signal generator, or it can be rack mounted (with or without handles). Hardware can be ordered as a kit to facilitate either preference. [Table 2-1](#) lists the part numbers for these kits.

Table 2-1 **Front Handle and Rack Mount Flange Kits**

Description	Part Number
Rack Mount Kit without Handles	5063-9215
Front Handle Kit	5063-9228
Rack Mount Kit with Handles	5063-9222

PSG Documentation

Table 2-2 lists the part numbers and descriptions for documentation available in hardcopy and CD-ROM format.

Table 2-2 Available PSG Documentation

Document Type	Description	Part Number
PSG Document Set	<ul style="list-style-type: none"> • user's, programming, and calibration guides • error messages • data sheet (technical specifications) 	E8251-90020
Documentation CD-ROM	<ul style="list-style-type: none"> • PDF files of the PSG documentation set, installation guide, and service guide • Intuilink software • programming examples 	E8251-90021
Installation Guide	<ul style="list-style-type: none"> • installation instructions and requirements • operation verification procedure • warranty, safety, and regulatory information 	E8251-90022
User's Guide	<ul style="list-style-type: none"> • description of features and functions • fundamental signal generator operation tutorials • optimization procedures • basic troubleshooting • key descriptions and softkey menu maps 	E8251-90023
Programming Guide	<ul style="list-style-type: none"> • SCPI command reference • programming examples • command compatibility tables 	E8251-90025
Error Messages	<ul style="list-style-type: none"> • error message definitions 	E8251-90027
Data Sheet	<ul style="list-style-type: none"> • available options • warranted specifications and typical performance 	5988-2412EN
Calibration Guide	<ul style="list-style-type: none"> • service software instructions • performance tests and adjustment procedures 	E8251-90035
Service Guide	<ul style="list-style-type: none"> • assembly level documentation • troubleshooting procedures 	E8251-90030

Proper Usage and Cleaning

The signal generator cover protects against physical contact with internal assemblies that contain hazardous voltages, but does not protect against the entrance of water. To avoid damage and personal injury, ensure that liquid substances are positioned away from your signal generator.

WARNING **Personal injury may result if the signal generator is not used as specified. Unspecified use impairs the protection provided by the equipment. The signal generator must be used with all means for protection intact.**

Cleaning Suggestions

To ensure good connections, the connectors on the front and rear panels of the signal generator need to be cleaned regularly.

To prevent dust build-up that could potentially obstruct ventilation, clean the signal generator cover periodically. Use a dry cloth, or one slightly dampened with water, to clean the external case parts.

WARNING **Electrical shock may result if the signal generator is not disconnected from the mains supply before cleaning. Do not attempt to clean internally.**

Contacting Agilent Technologies

A current list of Agilent Technologies Sales and Service Offices can be accessed on the internet at <http://www.agilent.com/find/assist>.

For the latest product and support information, application literature, and more, visit the PSG website at <http://www.agilent.com/find/psg>.

If you do not have access to the internet, refer to the information below to contact your nearest Agilent Technologies representative.

Table 2-3 Contacting Agilent

United States (tel) 1 800 452 4844	Latin America (tel) (305) 269 7500 (fax) (305) 269 7599	Canada (tel) 1 877 894 4414 (fax) (905) 282-6495	Europe (tel) (+31) 20 547 2323 (fax) (+31) 20 547 2390
New Zealand (tel) 0 800 738 378 (fax) (+64) 4 495 8950	Japan (tel) (+81) 426 56 7832 (fax) (+81) 426 56 7840	Australia (tel) 1 800 629 485 (fax) (+61) 3 9210 5947	

Asia Call Center Numbers		
Country	Phone Number	Fax Number
Singapore	1-800-375-8100	(65) 836-0252
Malaysia	1-800-828-848	1-800-801664
Philippines	(632) 8426802 1-800-16510170 (PLDT Subscriber Only)	(632) 8426809 1-800-16510288 (PLDT Subscriber Only)
Thailand	(088) 226-008 (outside Bangkok) (662) 661-3999 (within Bangkok)	(66) 1-661-3714
Hong Kong	800-930-871	(852) 2506 9233
Taiwan	0800-047-866	(886) 2 25456723
People's Republic of China	800-810-0189 (preferred) 10800-650-0021	10800-650-0121
India	1-600-11-2929	000-800-650-1101

Returning a Signal Generator to Agilent Technologies

To return your signal generator to Agilent Technologies for servicing, follow these steps:

1. Gather as much information as possible regarding the signal generator's problem.
2. Call the phone number listed in [Table 2-3](#) appropriate to the signal generator's location.

After sharing information regarding the signal generator and its condition, you will receive information regarding where to ship your signal generator for repair.

3. Ship the signal generator in the original factory packaging materials, if available, or use similar packaging to properly protect the signal generator.

3 Operation Verification

Performing Operation Verification

Operation verification is a series of tests that, when completed, will either ensure that the signal generator is operating correctly, or will assist in pointing to the problem area. Operation verification does not ensure performance to specifications, but should provide a level of confidence that the signal generator is operating correctly within a minimum amount of time.

Operation verification is appropriate for incoming inspection, after repair (when a full calibrated performance is not required), or whenever the integrity of the signal generator is in question. Individual tests may be performed in any order, however, the order of the list below is recommended.

Perform the following tests for operation verification:

1. [“Performing a Self-Test” on page 21](#)
2. [“Checking the Maximum Leveled Power” on page 23](#)
3. [“Checking the Output Power” on page 25](#)

NOTE Throughout this section, all references to pressing the **Preset** hardkey assume that the preset state is set to normal (factory-defined preset state).

To ensure that the preset state is set to normal, press **Utility > Power On/Preset > Preset Normal User** until Normal is highlighted.

Performing a Self-Test

The self-test is a series of internal tests that checks different signal generator functions. If this test fails, refer to [“Self-Test Failure” on page 22](#) for further instructions.

Perform the following procedure to run a self-test:

1. Disconnect all external cables, including GPIB, LAN, and RS-232 cables.
2. Press **Preset > Utility > Instrument Info/Help Mode > Self Test**.

The following message should appear:

- The current status of the self-test is: Incomplete. Not all tests have been run.

3. Press **Run Complete Self Test**.

While the self-test is running, an activity bar is displayed on the screen indicating the test progress.

If **Abort** is pressed while the self-test are running, the following message will be displayed:

- The current status of the self-test is: Incomplete. Not all tests have been run.

When the self-test is complete, one of the following messages will be displayed:

- The current status of the self-test is: Passed
- The current status of the self-test is: Failure. One or more tests have failed. System diagnostics indicate this test as the root failure: xxx

The number of tests that passed and failed are displayed in the lower left-hand corner of the display. If the signal generator fails only one test, the display shows the title of the failed test. If the signal generator fails more than one test, the test number of the most significant failure is shown.

Self-Test Failure

If a self-test failure occurs, perform the following procedure:

1. Make sure all external cables, including GPIB, LAN, and RS-232 cables, are disconnected from the signal generator and perform the self-test again.
2. If the self-test continues to fail, send the signal generator to an Agilent service center for repair, with a detailed description of the failed test(s) and any other error messages that appeared on the display.

Refer to [“Returning a Signal Generator to Agilent Technologies”](#) on page 18 for signal generator return instructions.

Checking the Maximum Leveled Power

This test verifies the maximum leveled output power of the signal generator.

Perform the following procedure to check the maximum leveled power:

1. Press **Preset**.
2. Attach a 50Ω load to the RF OUTPUT.
A power sensor, attenuator, or 50Ω termination is an example of a 50Ω load.
3. Press **RF On/Off**. The **RF On** annunciator is now displayed.
4. Press **Mod On/Off**. The **Mod Off** annunciator is now displayed.
5. Press **Amplitude** and enter a value from [Table 3-1](#) that is applicable to your model and options.
6. Press **Sweep/List > Configure Step Sweep**.
7. Press **Freq Start** and enter the start frequency value listed in [Table 3-1](#) that corresponds to the amplitude value entered in step 5.
8. Press **Freq Stop** and enter the corresponding stop frequency listed in [Table 3-1](#).
9. Press **# Points** and enter the number of corresponding points listed in [Table 3-1](#).
10. Press **Return > Sweep > Freq**. The **SWEEP** annunciator is now on and a continuous sweep will begin.
During the sweep, the progress bar becomes active on the display, indicating the status of the current sweep.
11. Watch the display and ensure that the **Unlevel** annunciator does not appear at any time during a full sweep.
The **Unlevel** annunciator may turn on and off, or remain on; both conditions indicate a failure. If this occurs, refer to [“Maximum Leveled Power Check Failure”](#) on page 24 for further instructions.
12. Press **Sweep > Off**.
13. Repeat steps 5-12 for each frequency range, specific to your model number and options.

Table 3-1 Frequency and Power Level Limits

	Amplitude		Start Frequency	Stop Frequency	# Points
	Standard	Option 1EA			
20 GHz Models (E8251A & E8241A)	13 dBm	16 dBm	250 kHz	3.2 GHz	50
	13 dBm	20 dBm	3.21 GHz	20 GHz	200
40 GHz Models (E8254A & E8244A)	9 dBm	15 dBm	250 kHz	3.2 GHz	50
	9 dBm	18 dBm	3.21 GHz	20 GHz	200
	9 dBm	14 dBm	20.1 GHz	40 GHz	200
20 GHz Models (with Option 1E1)	11 dBm	15 dBm	250 kHz	3.2 GHz	50
	11 dBm	18 dBm	3.21 GHz	20 GHz	200
40 GHz Models (with Option 1E1)	7 dBm	14 dBm	250 kHz	3.2 GHz	50
	7 dBm	16 dBm	3.21 GHz	20 GHz	200
	7 dBm	12 dBm	20.1 GHz	40 GHz	200

Maximum Levelled Power Check Failure

If a maximum levelled power check fails, perform the following procedure:

1. Ensure that the Unlocked annunciator is not displayed.
 If this condition occurs, refer to the troubleshooting section of the PSG Family Calibration Guide.
2. Ensure that the RF OUTPUT connector is connected to a 50Ω load.
3. Ensure that the power level entered corresponds to the value listed in [Table 3-1](#).
4. Refer to [Table 3-2](#) for the recommended equipment and measure the output power.
 If the measured power level is more than the power level listed in [Table 3-1](#), turn the front panel knob counterclockwise until the measured power level equals the power level in [Table 3-1](#).
5. Note the signal generator front panel amplitude value and use it to repeat the maximum levelled power check.
 If all of the above steps are followed and the check continues to fail, contact the nearest Agilent Technologies call center for assistance. Refer to [“Contacting Agilent Technologies” on page 17](#) for contact information.

Checking the Output Power

This test verifies the CW output power from the signal generator. If this test fails, refer to [“Problems with Output Power” on page 28](#) for further instructions.

[Table 3-2](#) shows the preferred equipment for use with the signal generator when performing this test.

Table 3-2 Recommended Equipment

E8241A E8251A	E8244A E8254A	Test Equipment	Preferred Model or Alternate Model
✓	✓	Power Meter	Agilent E4418B E-Series power meter or Agilent E4419A/B E-Series power meter
✓	✓	Power Sensor, Input: Type-N (m)	Agilent E9304A E-Series power sensor or Agilent 8482A power sensor
✓		Power Sensor, Input: APC 3.5 (m)	Agilent E4413A E-Series power sensor
	✓	Power Sensor, Input: 2.4 mm (m)	Agilent 8487A Option H84 power sensor Option H84 adds a Standards Lab Calibration
	✓	Adapter, 2.4 mm (f) to Type-N (f)	Agilent 11903B 2.4 mm (f) to Type-N (f) adapter
	✓	Adapter, 2.4 mm (f) to (f)	Agilent 11900B 2.4 mm (f) to (f) adapter
✓	✓	Adapter, APC 3.5 (f) to (f)	Agilent 1250-1749 APC 3.5 (f) to (f) adapter
✓		Adapter, APC 3.5 (f) to Type-N (m)	Agilent 1250-1744 APC 3.5 (f) to Type-N (m) adapter

Operation Verification
Checking the Output Power

Perform the following procedure to check the signal generator output power:

1. Zero and calibrate the power sensor to the power meter as shown:

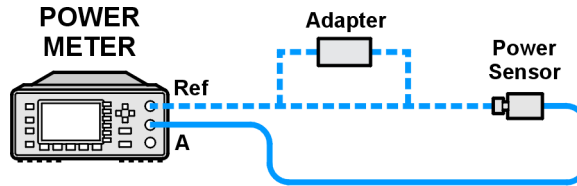

2. Connect the equipment as shown:

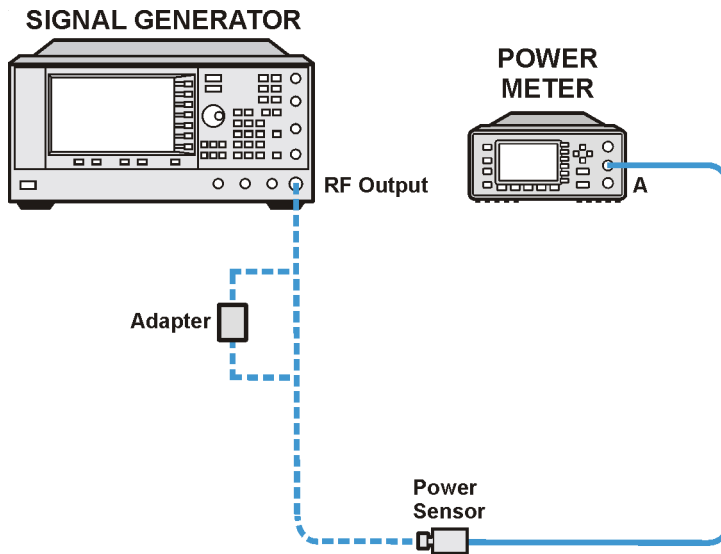

3. Press **Preset**.
4. Press **RF On/Off**. The **RF On** annunciator is now displayed.
5. Press **Mod On/Off**. The **Mod Off** annunciator is now displayed.
6. Press **Frequency** and enter the first frequency value listed in [Table 3-1](#).
7. Press **Amplitude** and enter the amplitude value for your option and frequency value.
8. Measure the power level.
9. Repeat step 6 through 8 and measure each remaining frequency listed in [Table 3-3](#), if the power level measured is within the acceptable limits.

Table 3-3 Leveled Output Power Limits

20 GHz Models (E8251A & E8241A)				40 GHz Models (E8254A & E8244A)			
Frequency	Amplitude		Limits	Frequency	Amplitude		Limits
	Option	dBm	dB		Option	dBm	dB
250 kHz	None	13	±0.6	250 kHz	None	9	±0.6
	1EA	16	±0.6		1EA	15	±0.6
	1E1	11	±0.6		1E1	7	±0.6
	1E1 & 1EA	15	±0.6		1E1 & 1EA	14	±0.6
3.2 GHz	None	13	±0.8	3.2 GHz	None	9	±0.8
	1EA	16	±0.8		1EA	15	±0.8
	1E1	11	±0.8		1E1	7	±0.8
	1E1 & 1EA	15	±0.8		1E1 & 1EA	14	±0.8
20 GHz	None	13	±0.8	20 GHz	None	9	±0.9
	1EA	20	±0.8		1EA	18	±1.0
	1E1	11	±0.8		1E1	7	±0.9
	1E1 & 1EA	18	±0.8		1E1 & 1EA	16	±1.0
				40 GHz	None	9	±0.9
					1EA	14	±1.0
					1E1	7	±0.9
					1E1 & 1EA	12	±1.0

NOTE Limit values are due to power meter uncertainty.

Problems with Output Power

If a problem occurs when verifying output power levels, perform the following procedure:

1. Verify the power sensor being used in this test is the appropriate sensor.
2. Verify the power sensor calibration factors, if required, are correct.
3. Verify the power sensor is properly calibrated to the power meter.

If the problem continues, perform a Power Level Accuracy performance test. Refer to the PSG Family Calibration Guide.

4 Regulatory Information

Statement of Compliance

This product has been designed and tested in accordance with IEC Publication 61010, *Safety Requirements for Electronic Measuring Apparatus*, and has been supplied in a safe condition. The instruction documentation contains information and warnings which must be followed by the user to ensure safe operation and to maintain the product in a safe condition.

Warranty

This Agilent Technologies instrument product is warranted against defects in material and workmanship for a period of three years from date of shipment. During the warranty period, Agilent Technologies will, at its option, either repair or replace products which prove to be defective.

For warranty service or repair, this product must be returned to a service facility designated by Agilent Technologies. Buyer shall prepay shipping charges to Agilent Technologies and Agilent Technologies shall pay shipping charges to return the product to Buyer. However, Buyer shall pay all shipping charges, duties, and taxes for products returned to Agilent Technologies from another country.

Agilent Technologies warrants that its software and firmware designated by Agilent Technologies for use with an instrument will execute its programming instructions when properly installed on that instrument. Agilent Technologies does not warrant that the operation of the instrument, or software, or firmware will be uninterrupted or error-free.

Limitation of Warranty

The foregoing warranty shall not apply to defects resulting from improper or inadequate maintenance by Buyer, Buyer-supplied software or interfacing, unauthorized modification or misuse, operation outside of the environmental specifications for the product, or improper site preparation or maintenance.

NO OTHER WARRANTY IS EXPRESSED OR IMPLIED. AGILENT TECHNOLOGIES SPECIFICALLY DISCLAIMS THE IMPLIED WARRANTIES OF MERCHANTABILITY AND FITNESS FOR A PARTICULAR PURPOSE.

Exclusive Remedies

THE REMEDIES PROVIDED HEREIN ARE BUYER'S SOLE AND EXCLUSIVE REMEDIES. AGILENT TECHNOLOGIES SHALL NOT BE LIABLE FOR ANY DIRECT, INDIRECT, SPECIAL, INCIDENTAL, OR CONSEQUENTIAL DAMAGES, WHETHER BASED ON CONTRACT, TORT, OR ANY OTHER LEGAL THEORY.

Assistance

Product maintenance agreements and other customer assistance agreements are available for Agilent Technologies products. For any assistance, contact Agilent Technologies. (Refer to “[Contacting Agilent Technologies](#)” on page 17.)

Certification

Agilent Technologies certifies that this product met its published specifications at the time of shipment from the factory. Agilent Technologies further certifies that its calibration measurements are traceable to the United States National Institute of Standards and Technology, to the extent allowed by the Institute's calibration facility, and to the calibration facilities of other International Standards Organization members.

Declaration of Conformity

DECLARATION OF CONFORMITY	
According to ISO/IEC Guide 22 and CEN/CENELEC EN 45014	
Manufacturer's Name:	Agilent Technologies, Inc.
Manufacturer's Address:	1400 Fountaingrove Parkway Santa Rosa, CA 95403-1799 USA
Declares that the products	
Product Name:	Signal Generator
Model Number:	E8241A, E8244A, E8251A, E8254A
Product Options:	This declaration covers all options of the above products.
Conform to the following product specifications:	
EMC: IEC 61326-1:1997+A1:1998 / EN 61326-1:1997+A1:1998	
<u>Standard</u>	<u>Limit</u>
CISPR 11:1990 / EN 55011-1991	Group 1, Class A
IEC 61000-4-2:1995+A1998 / EN 61000-4-2:1995	4 kV CD, 8 kV AD
IEC 61000-4-3:1995 / EN 61000-4-3:1995	3 V/m, 80 - 1000 MHz
IEC 61000-4-4:1995 / EN 61000-4-4:1995	0.5 kV sig., 1 kV power
IEC 61000-4-5:1995 / EN 61000-4-5:1996	0.5 kV L-L, 1 kV L-G
IEC 61000-4-6:1996 / EN 61000-4-6:1998	3 V, 0.15 – 80 MHz
IEC 61000-4-11:1994 / EN 61000-4-11:1998	1 cycle, 100%
Safety: IEC 61010-1:1990 + A1:1992 + A2:1995 / EN 61010-1:1993 +A2:1995 CAN/CSA-C22.2 No. 1010.1-92	
Supplementary Information:	
The products herewith comply with the requirements of the Low Voltage Directive 73/23/EEC and the EMC Directive 89/336/EEC and carry the CE-marking accordingly.	
Santa Rosa, CA, USA 20 February, 2001	
	Greg Pfeiffer/Quality Engineering Manager
For further information, please contact your local Agilent Technologies sales office, agent or distributor.	
Revision: A	

Compliance with German Noise Requirements

This is to declare that this instrument is in conformance with the German Regulation on Noise Declaration for Machines (Laermangabe nach der Maschinenlaermverordnung -3.GSGV Deutschland).

Table 4-1 German Noise Requirements

Acoustic Noise Emission/Geraeuschemission	
LpA < 70 dB	LpA < 70 dB
Operator position	am Arbeitsplatz
Normal position	normaler Betrieb
per ISO 7779	nach DIN 45635 t.19

A

ac power cord
 connection, 8
 localization, 9
ac symbol, 3
accessories, 14
address, GPIB, 12
adjusting display during remote operation,
 11
Agilent Technologies
 Asia call center numbers, 17
 contact information, 17
 product support URL, 17
 returning a product to, 18
altitude requirements, 7
assistance, 17, 32
Australian Communications Authority
 (C-tick) mark, 3

B

brightness adjustment, 10

C

Canadian Standards Association (CSA)
 mark, 3
checking the shipment, 6
cleaning suggestions, 16
configuring
 global settings, 10
 GPIB interface, 12
 LAN interface, 12
 remote control settings, 12
 RS-232 interface, 13
contrast adjustment, 10
customer support. *See* support, 17

D

display adjustment
 contrast and brightness, 10
 inverse video, 10
 light, 11
 screen saver, 11
 update during remote operation, 11
documentation
 available, 15
 disclaimer, 15

E

European Community (CE) trademark, 3

F

failures
 maximum level power check, 24
 output power check, 28
 self-test, 22

G

German noise requirements, 35
global settings, 10
GPIB configuration
 address, 12
 interface, 12

H

hostname configuration, 12

I

IEC Publication 61010, 30
instruction manual symbol, 3
inverse video adjustment, 10
IP address, setting, 12
ISM1-A symbol, 3

K

kits
 front handle, 14
 rack mount, with handles, 14
 rack mount, without handles, 14

L

LAN configuration
 hostname, 12
 IP address, 12

M

maintenance agreements, 32

O

ordering accessories, 14
output power test
 recommended equipment, 25

P

parallel interface. *See* GPIB configuration, 12
power on symbol, 3
product support URL, 17
PSG documentation, 15

Index

R

recommended equipment, [25](#)

remote configuring, [12](#)

requirements

altitude, [7](#)

electrical, [7](#)

environmental, [7](#)

German Noise, [35](#)

humidity, [7](#)

temperature, [7](#)

ventilation, [7](#)

RS-232 configuration

baud rate, [13](#)

echo, [13](#)

pace, [13](#)

reset, [13](#)

S

screen saver adjustment, [11](#)

standby symbol, [3](#)

support

Asia call center numbers, [17](#)

contact information, [17](#)

general information, [17](#)

symbols

ac, [3](#)

CE mark, [3](#)

CSA mark, [3](#)

C-tick mark, [3](#)

instruction manual, [3](#)

ISM1-A, [3](#)

power on, [3](#)

standby, [3](#)

T

temperature requirements, [7](#)

V

ventilation

holes, [7](#)

requirements, [7](#)